

男子

優勝

15 | 16

7

21 | 3

9 | 21

23 | 0

5

10 | 11

19 | 4

6

2 | 22

1

2

3

4

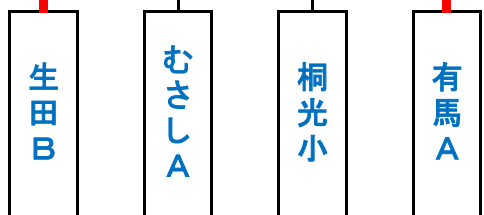
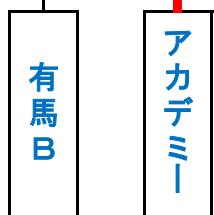
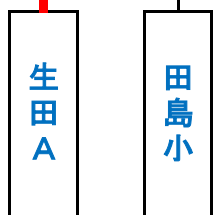

3決

6 | 23

8

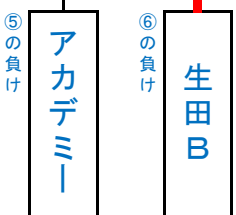

5決

13 | 9

11

4 | 18

14 | 4

9

10

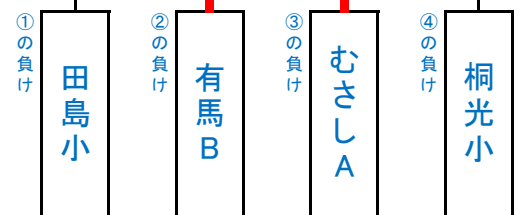

12

10 | 9

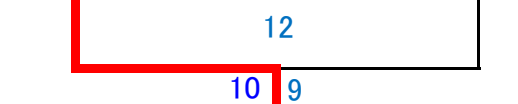

女子

優勝

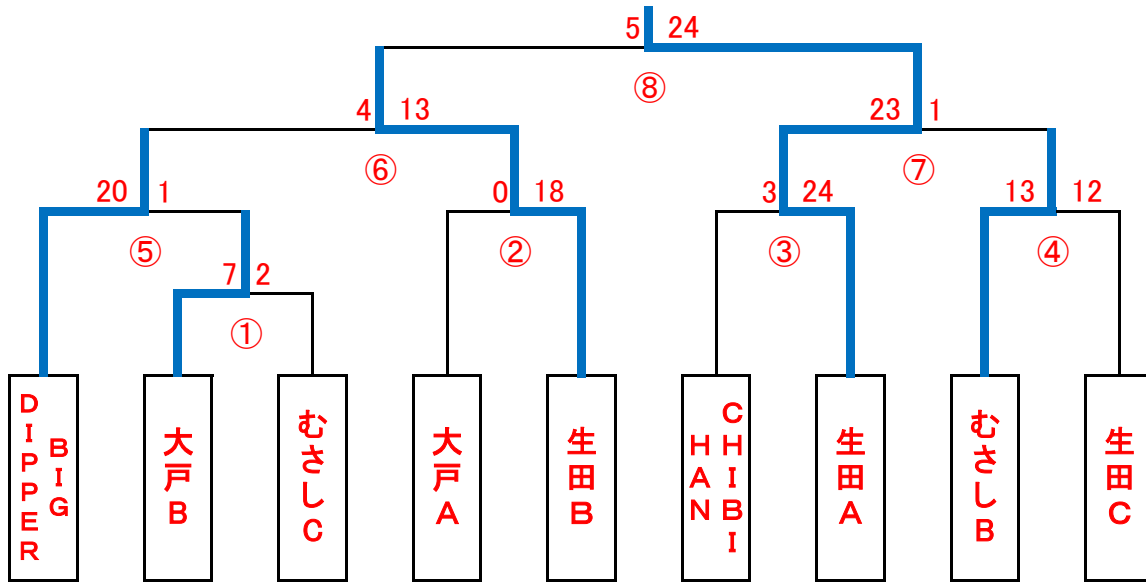

3決

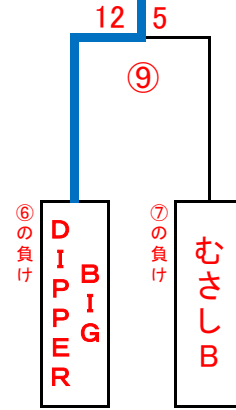

5決

